

APPLICATION

This flush access door is ideal for use on Acoustical walls and ceilings where maintaining STC Rating (Sound Transmission Class) and OITC Rating (Outdoor-In-door Transmission Class) is required.

FEATURES

- Zinc coated steel provides superior corrosion resistance.
- Drywall taping bead flange
- Type 304 Stainless steel with #4 satin polish also available.
- Tested and evaluated to ASTM: E90(09), ASTM: E413(16), ASTM: E1332(16) and certified to STC Rating 64 and OITC Rating 54

SPECIFICATIONS

MATERIAL: 18 Gauge Satin Coat Steel

DOOR: 18 Gauge, encapsulated design with 2" thick acoustical mineral liner and 0.11" thick mineral filled vinyl barrier

FRAME: 18 Gauge, press bent for strength and rigidity, with 1" wide trim flanges and 1" thick acoustical mineral liner

GASKET: 1/8" x 1/2" Neoprene Rubber with Adhesive.

HINGE: Continuous exposed stainless steel piano hinge

STANDARD LOCK: Slotted Screwdriver Cam Latch

OPTIONAL LOCK: Torx head with security pin

ACOUSTIC RATING: This door has been tested and evaluated to ASTM: E90(09), ASTM: E413(16), ASTM: E1332(16) and certified to STC Rating 64 and OITC Rating 54.

FINISH: Baked White Prime Coat (Additional nish paint is recommended for superior corrosion resistance.



DIMENSIONS AND APPEARANCE

>> CLICK TO VIEW ADDITIONAL DETAILS AND PRICING <<

STANDARD SIZES:

DOOR SIZE W x H INCHES (MM)	LATCHES	WEIGHT LBS KG	
12 x 12 (305 x 305)	1	14.0	6.4
16 x 16 (406 x 406)	1	26.0	11.8
18 x 18 (457 x 457)	1	35.0	15.9
24 x 24 (610 x 610)	1	42.0	19.1
24 x 36 (610 x 914)	2	62.0	28.1

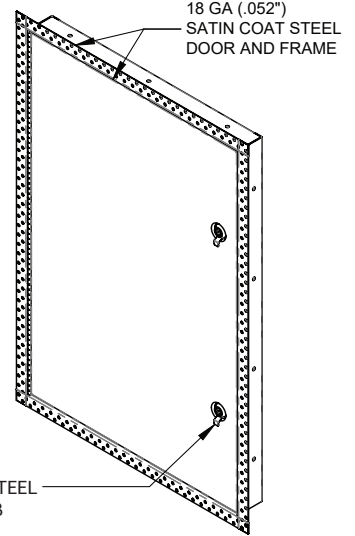
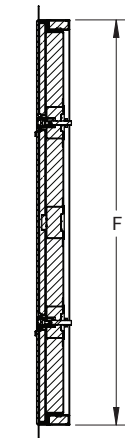
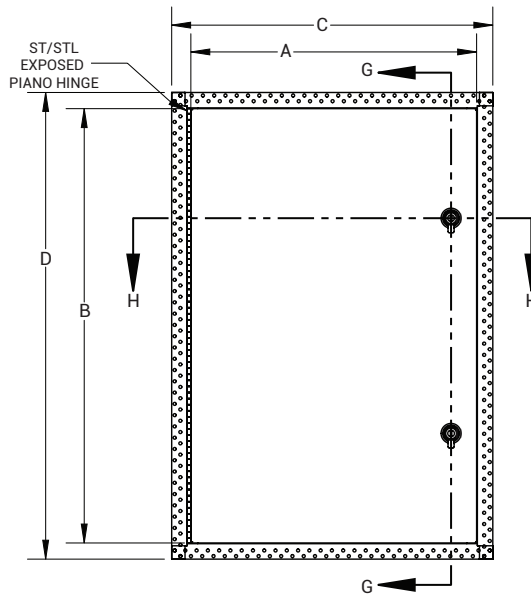
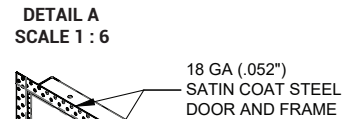
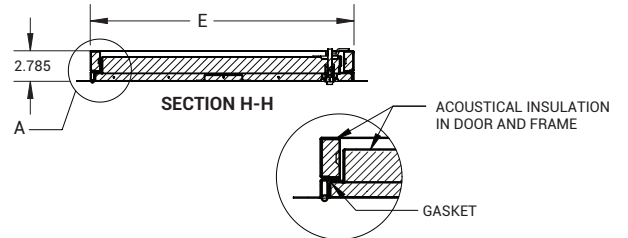

Proprietary property of Acudor Products, Inc., sold and distributed with proper authorization





For a complete list of options visit www.AcudorAccessPanels.com

PROJECT DATA

Custom Sizes Available - Fast!

PROJECT NAME :	QTY	W	H	OPTIONS
ARCHITECT :				
DEALER :				
CONTRACTOR :				
LOCATION :	SPECIAL INSTRUCTIONS :			
DATE :	SUBMITTAL APPROVAL : (signature or stamp)			
TAGGING INSTRUCTIONS :				

Scan  or  Click



To view Pricing and Additional Product Info.



TELEPHONE:
1-888-622-8367
FAX:
1-888-626-2907



PO BOX 4668
PMB 76520
NEW YORK,
NEW YORK 10163-4668
US



WEBSITE:
www.AcudorAccessPanels.com
E-MAIL:
info@AcudorAccessPanels.com



ACF-2064-DW

ACOUSTICAL ACCESS DOOR WITH DRYWALL FLANGE

NOMINAL SIZE	A	B	C	D	E	F	LOCK QTY
12 x 12 (305mm x 305mm)	11.567 (294mm)	11.818 (300mm)	14.484 (368mm)	14.484 (368mm)	12.044 (306mm)	12.044 (306mm)	1
16 x 16 (406mm x 406mm)	15.567 (395mm)	15.818 (402mm)	18.484 (469mm)	18.484 (469mm)	16.044 (408mm)	16.044 (408mm)	1
18 x 18 (457mm x 457mm)	17.567 (446mm)	17.818 (453mm)	20.484 (520mm)	20.484 (520mm)	18.044 (458mm)	18.044 (458mm)	1
24 x 24 (610mm x 610mm)	23.567 (599mm)	23.818 (605mm)	26.484 (673mm)	26.484 (673mm)	24.044 (611mm)	24.044 (611mm)	1
24 x 36 (610mm x 914mm)	23.567 (599mm)	35.818 (910mm)	26.484 (673mm)	38.484 (977mm)	24.044 (611mm)	36.044 (915mm)	2

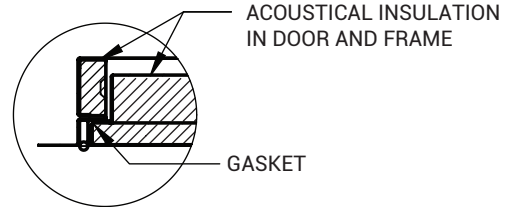
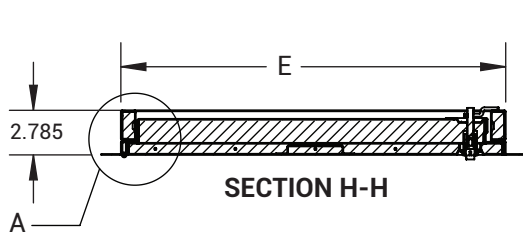

DETAIL A
SCALE 1 : 6

